

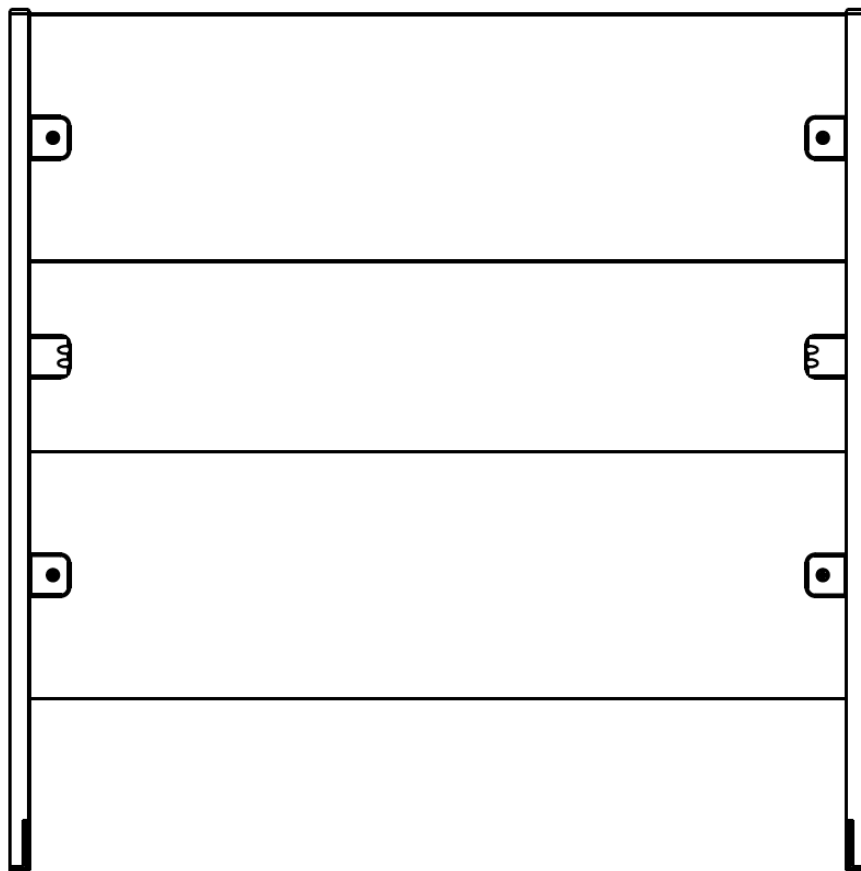

HAHN Lamellen



Hygiene-Spuck-Schutzwand

▶ **Typ 1** ◀

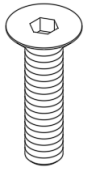

6x (T8)



2x (T9)



12x (T10)

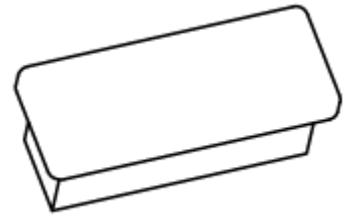

2x (T7)

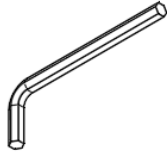

1x (T11)

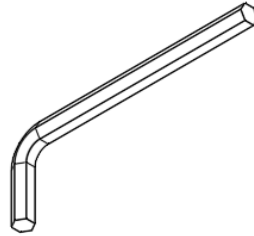

1x (T12)

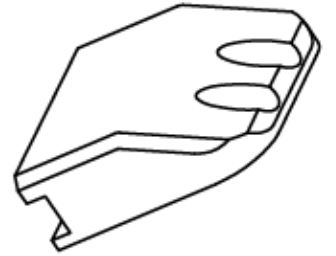

6x (T6)

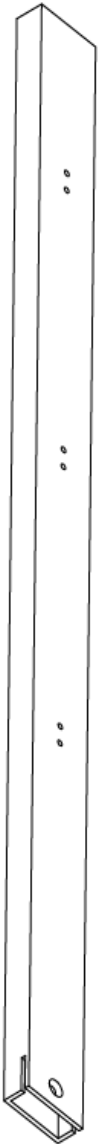

2x (T1)



3x (T4)

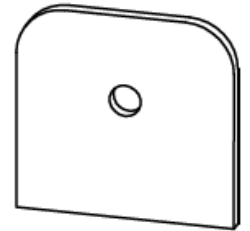

12x (T3)

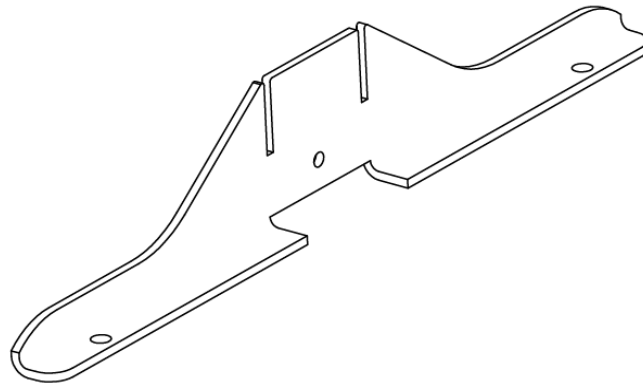

2x (T2)

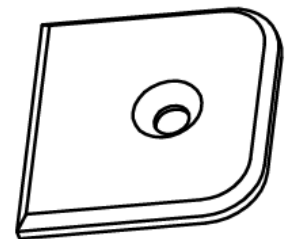

6x (T5)

1.

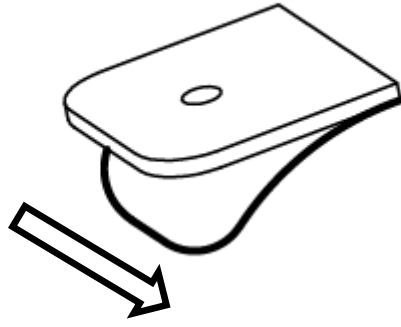

12x (T3)

2.

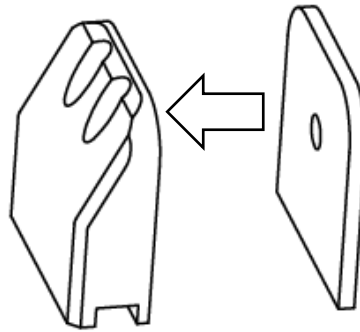

6x (T6 + T3)

3.

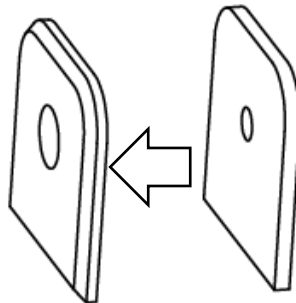

6x (T5 + T3)

4.

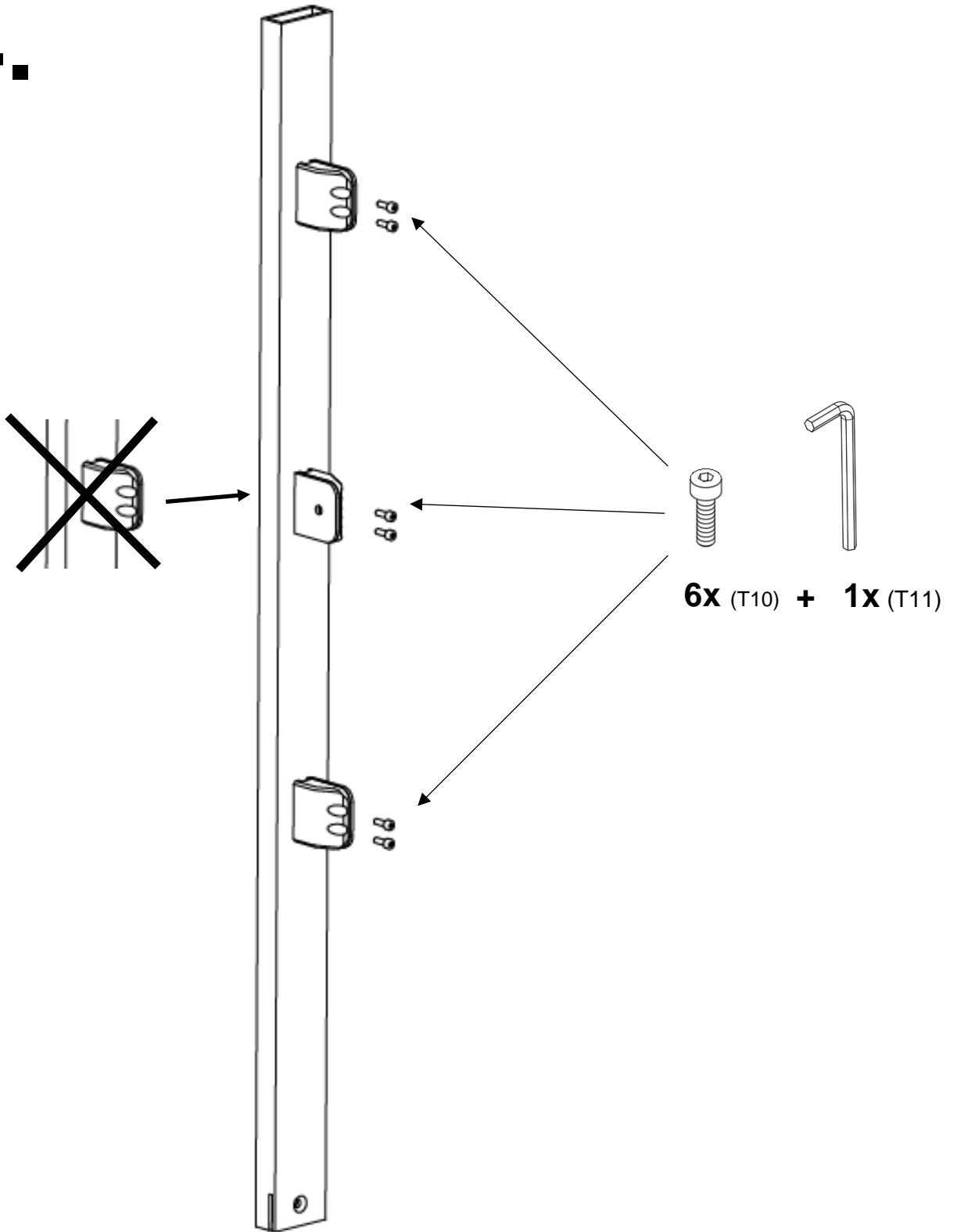

1x (T1, 6xT10, 3xT6, 3xT3)

5.

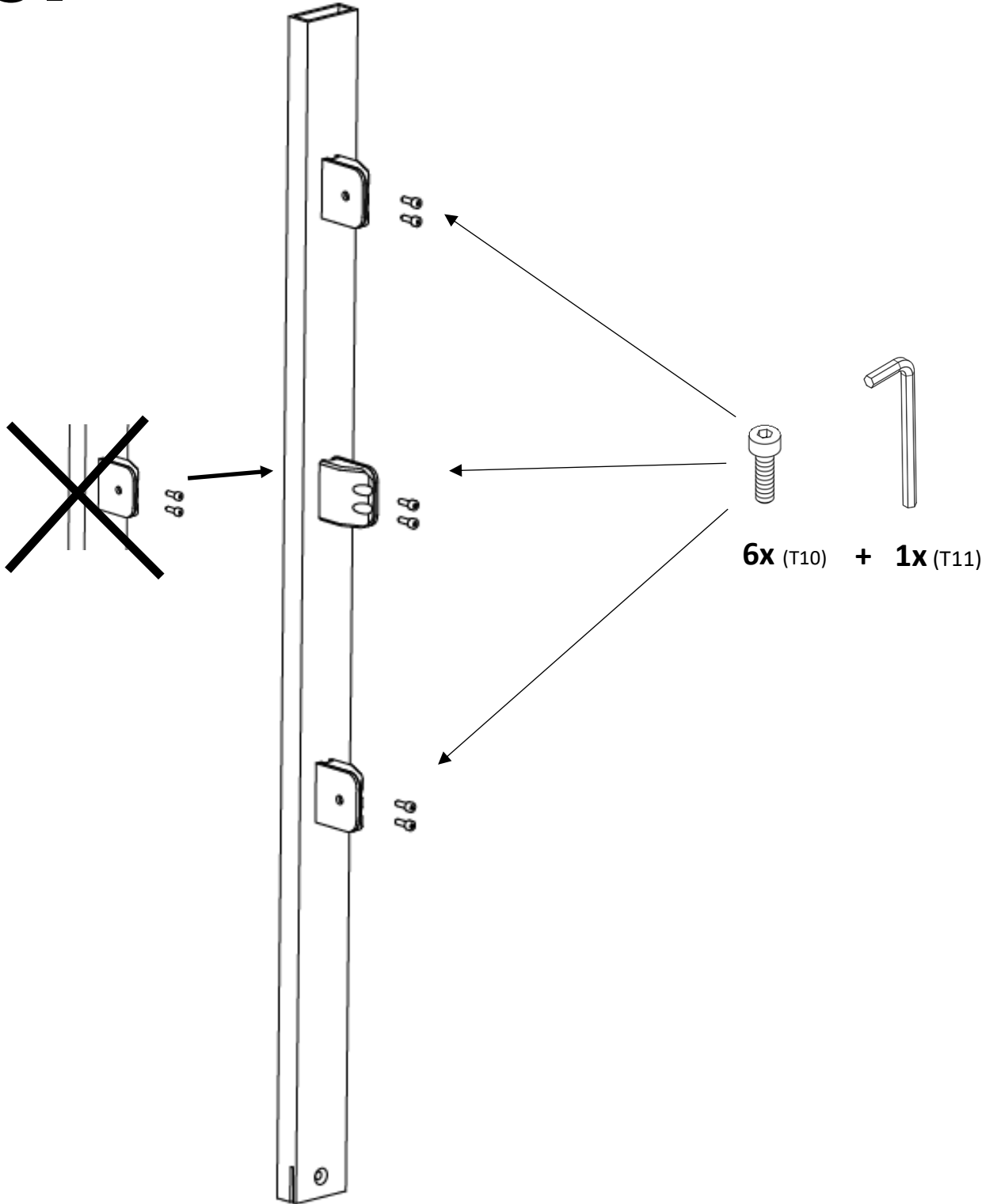

1x (T1, 6xT10, 3xT6, 3xT3)

6.

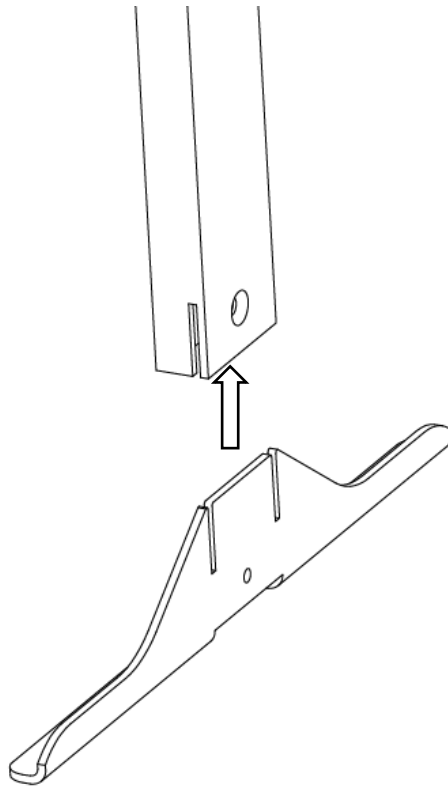

2x (T1 + T2)

7.

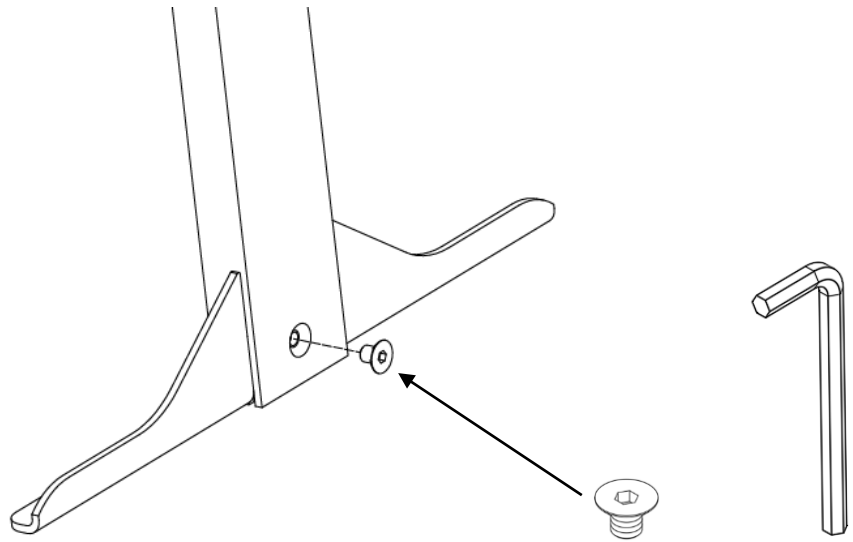

2x

1x (T9) + **1x** (T12)

8.

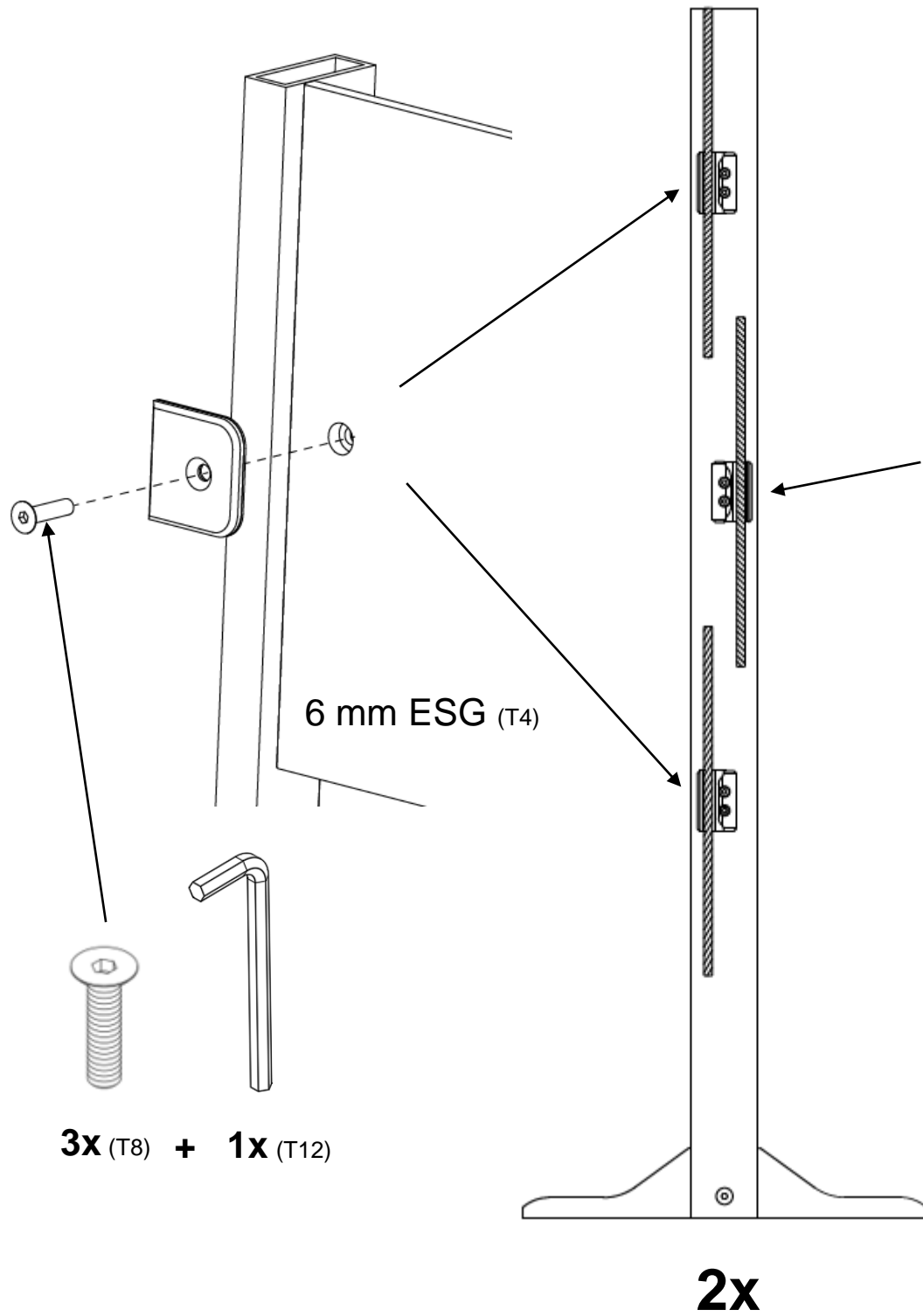

9.

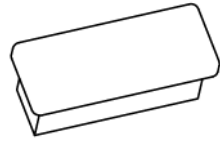

2x (T7)

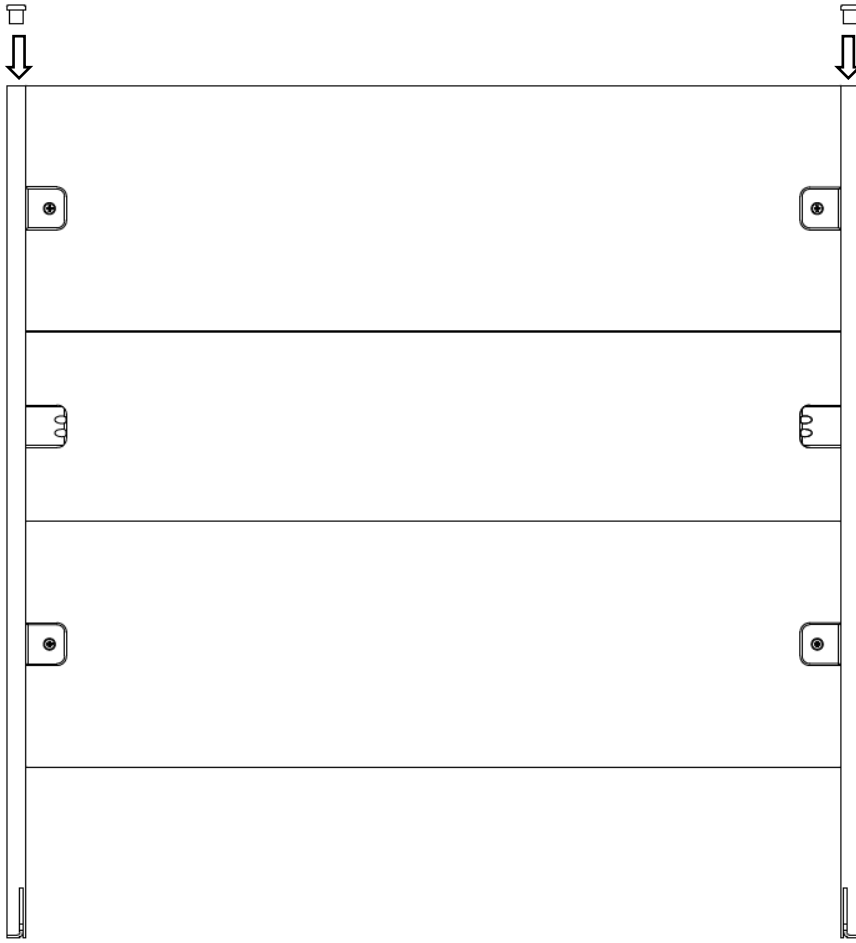

1x

Befestigung / Attachment:

Die „Hygiene – Spuck – Schutzwand“ muss entweder mit dem Trägermaterial verklebt werden (hierfür empfehlen wir den Kleber **XXX** von Tesa), oder für eine noch höhere Standfestigkeit mit dem Trägermaterial verschraubt werden (4 Schrauben pro „Hygiene – Spuck – Schutzwand“, nicht im Lieferumfang enthalten).

The „Hygiene-Spuck-Schutzwand“ has to be agglutinated with the base support material (we recommend using **XXX** Tesa), or, for better stability, be bolted to the base (4no screws for each unit, not provided with delivery).

XXX = Versuch steht noch aus

HAHN Lamellenfenster GmbH

Hafenstraße 5-7

63811 Stockstadt

Tel.: +49 (0) 6027 4162 20

Fax: +49 (0) 6027 4162 99

info@hahn-lamellenfenster.de

www.hahn-lamellenfenster.de